

Installation and user manual

Tower models

5P 650i

5P 850i

5P 1150i

5P 1550i



1U Rack models

5P 650i R

5P 850i R

5P 1150i R

5P 1550i R

Copyright © 2013 EATON
All rights reserved.

Service and support:
Call your local service representative

620-00082-02-i (en)

Certification Standards

UPS directives:

- Safety: IEC 62040-1: 2008 (C2)
- EMC: IEC 62040-2: 2005, VCCI
- Performance: IEC 62040-3: 2010

CE mark (EN 62040-1: 2008 and EN 62040-2: 2006 (C1))

Class B emission level CISPR 22: 2005 + A2 2006 (EN 55022)

Harmonics emission: IEC 61000-3-2 edition 3.2: 2009

Flickers emission: IEC 61000-3-3 edition 2: 2008

VCCI Notice

この装置は、情報処理装置等電波障害自主規制協議会（VCCI）の基準に基づくクラスA情報技術装置です。この装置を家庭環境で使用すると電波妨害を引き起こすことがあります。この場合には使用者が適切な対策を講ずるよう要求されることがあります。

The EC Declaration of Conformity is available upon request for products with a CE mark.

For copies of the EC Declaration of Conformity, contact Eaton Power Quality or check Eaton website: www.powerquality.eaton.com

Special Symbols

The following are examples of symbols used on the UPS or accessories to alert you to important information:



RISK OF ELECTRIC SHOCK - Observe the warning associated with the risk of electric shock symbol.



Important instructions that must always be followed.



Do not discard the UPS or the UPS batteries in the trash.
This product contains sealed lead acid batteries and must be disposed as it's explain in this manual.
For more information, contact your local recycling/reuse or hazardous waste center.



This symbol indicates that you should not discard waste electrical or electronic equipment (WEEE) in the trash. For proper disposal, contact your local recycling/reuse or hazardous waste center.



Information, advice, help.

1. Introduction.....	4
1.1 Environmental protection	4
2. Presentation	5
2.1 Standard installations.....	5
2.2 Tower rear panels.....	6
2.3 Rack rear panels	7
2.4 Control panel	8
2.5 LCD description	9
2.6 Display functions	10
2.7 User settings	10
3. Installation	12
3.1 Unpacking and contents check.....	12
3.2 Installation of tower models	13
3.3 Wall installation of rack models (650i R / 850i R / 1150i R)	13
3.4 Installation of rack models (650i R only)	14
3.5 Installation of rack models (850i R / 1150i R / 1550i R)	14
3.6 Communication ports	15
4. Operation.....	16
4.1 Start-up and Normal operation.....	16
4.2 Starting the UPS on Battery	16
4.3 UPS Shutdown	16
4.4 Operation on Battery Power	16
4.5 Return of AC Input Power.....	17
4.6 UPS remote control functions	17
5. Maintenance	18
5.1 Troubleshooting.....	18
5.2 Battery-module replacement	19
6. Appendices	21
6.1 Technical specifications.....	21

1. Introduction

Thank you for selecting an EATON product to protect your electrical equipment.

The 5P range has been designed with the utmost care.

We recommend that you take the time to read this manual to take full advantage of the many features of your UPS (Uninterruptible Power System).

Before installing 5P, please read the booklet presenting the safety instructions. Then follow the instructions in this manual.

To discover the entire range of EATON products and the options available for the 5P range, we invite you to visit our web site at www.eaton.com/powerquality or contact your EATON representative.

1.1 Environmental protection

EATON has implemented an environmental-protection policy. Products are developed according to an eco-design approach.

Substances

This product does not contain CFCs, HCFCs or asbestos.

Packing

To improve waste treatment and facilitate recycling, separate the various packing components.

- The cardboard we use comprises over 50 % of recycled cardboard.
- Sacks and bags are made of polyethylene.
- Packing materials are recyclable and bear the appropriate identification symbol 

Materials	Abbreviations	Number in the symbols 
Polyethylene terephthalat	PET	01
High-density polyethylene	HDPE	02
Polyvinyl chloride	PVC	03
Low-density polyethylene	LDPE	04
Polypropylene	PP	05
Polystyrene	PS	06

Follow all local regulations for the disposal of packing materials.

End of life

EATON will process products at the end of their service life in compliance with local regulations. EATON works with companies in charge of collecting and eliminating our products at the end of their service life.

Product

The product is made up of recyclable materials.

Dismantling and destruction must take place in compliance with all local regulations concerning waste. At the end of its service life, the product must be transported to a processing centre for electrical and electronic waste.

Battery

The product contains lead-acid batteries that must be processed according to applicable local regulations concerning batteries.

The battery may be removed to comply with regulations and in view of correct disposal.

2.1 Standard installations

Tower models

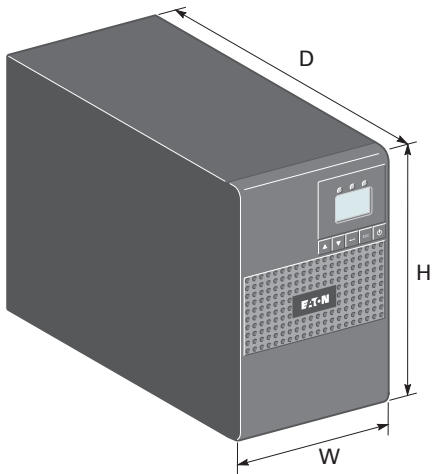

Description	Weights (kg/lb)	Dimensions (mm/inch) D x W x H
5P 650i	7.52 / 16.60	345 x 150 x 233 / 13.6 x 5.9 x 9.2
5P 850i	9.93 / 21.90	345 x 150 x 233 / 13.6 x 5.9 x 9.2
5P 1150i	10.91 / 24.10	345 x 150 x 233 / 13.6 x 5.9 x 9.2
5P 1550i	15.95 / 35.20	445 x 150 x 233 / 17.5 x 5.9 x 9.2

Rack models

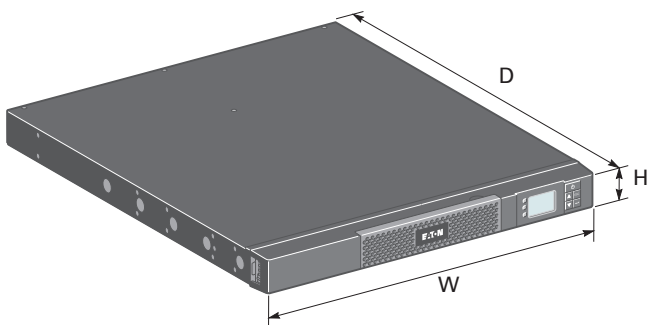

Description	Weights (kg/lb)	Dimensions (mm/inch) D x W x H
5P 650i R	8.6 / 19.00	363.5 x 438 x 43.2 / 14.3 x 17.2 x 1.7
5P 850i R	13.8 / 30.40	509 x 438 x 43.2 / 20.0 x 17.2 x 1.7
5P 1150i R	14.64 / 32.70	509 x 438 x 43.2 / 20.0 x 17.2 x 1.7
5P 1550i R	19.36 / 42.70	554 x 438 x 43.2 / 21.8 x 17.2 x 1.7

2. Presentation

2.2 Tower rear panels

5P 650i

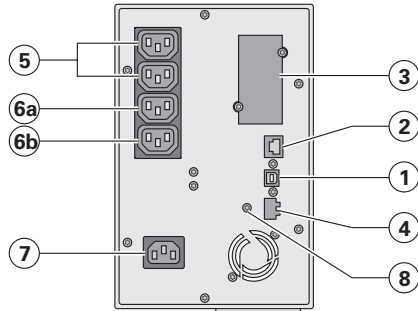

- (1) USB communication port
- (2) RS232 communication port
- (3) Slot for optional communication card
- (4) Connector for ROO (remote ON/OFF) or RPO (Remote Power Off) control
- (5) Outlets for connection of critical equipment (Primary group)
- (6a) Group 1: programmable outlets for connection of equipment
- (6b) Group 2: programmable outlets for connection of equipment
- (7) Socket for connection to AC-power source
- (8) Ground screw

5P 850i

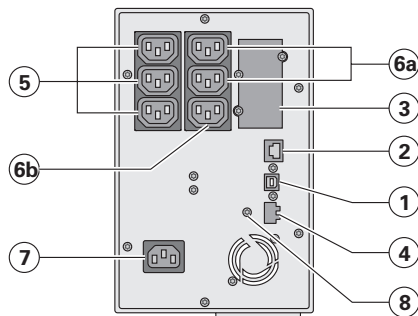

5P 1150i

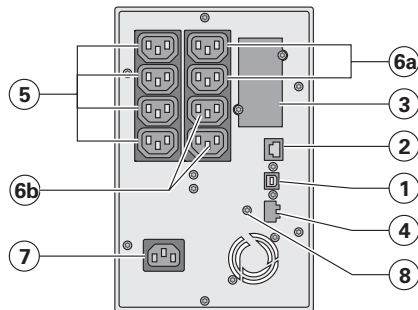

5P 1550i

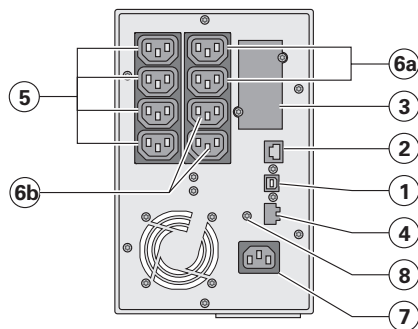

2. Presentation

2.3 Rack rear panels

5P 650i R / 5P 850i R

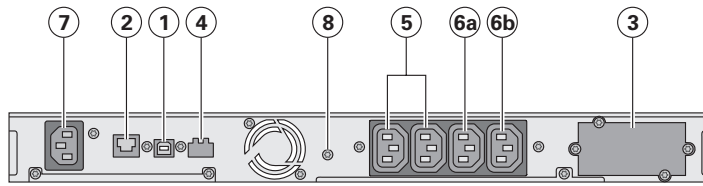

- (1) USB communication port
- (2) RS232 communication port
- (3) Slot for optional communication card
- (4) Connector for ROO (remote ON/OFF) or RPO (Remote Power Off) control
- (5) Outlets for connection equipment (Primary group)
- (6a) Group 1: programmable outlets for connection of equipment
- (6b) Group 2: programmable outlets for connection of equipment
- (7) Socket for connection to AC-power source
- (8) Ground screw

5P 1150i R

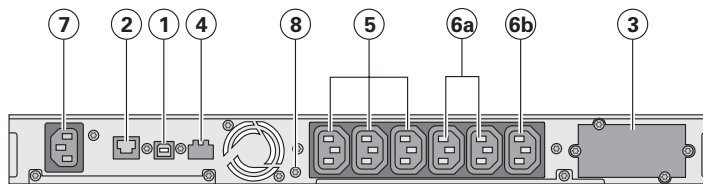

5P 1550i R

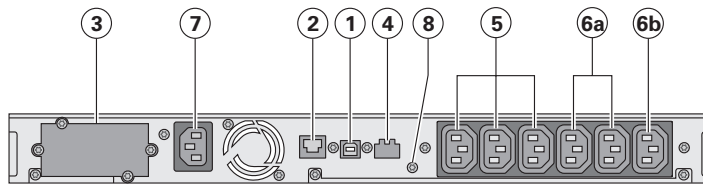

2. Presentation

2.4 Control panel

The UPS has a five-button graphical LCD. It provides useful information about the UPS itself, load status, events, measurements and settings.

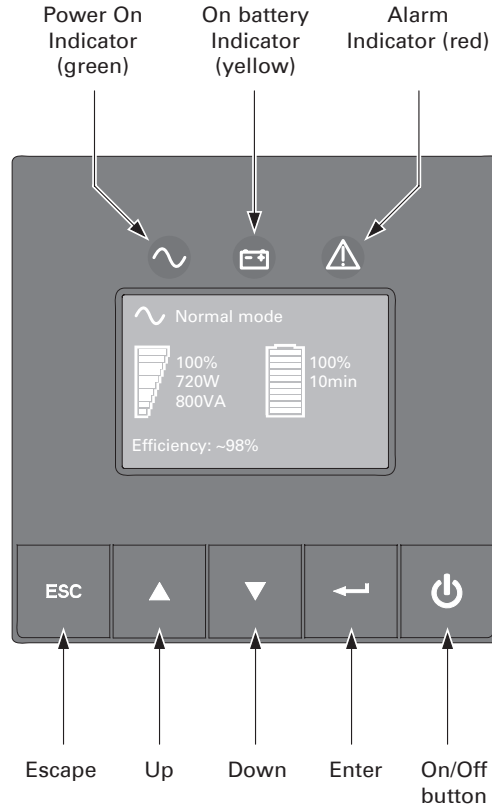

Tower models

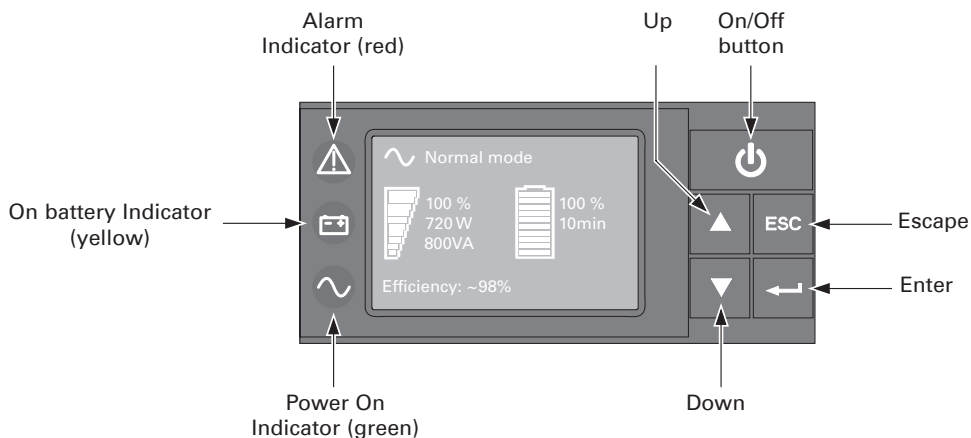

Rack models



The following table shows the indicator status and description :

Indicator	Status	Description
 Green	On	The UPS is operating normally
 Yellow	On	The UPS is on battery mode
 Red	On	The UPS has an active alarm or fault. See troubleshooting on page 18 for additional information.

2.5 LCD description

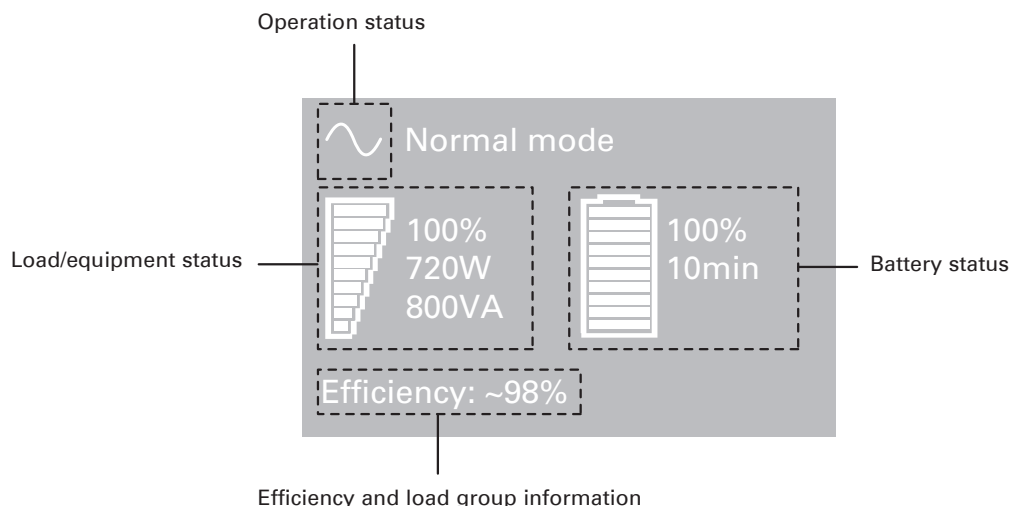







As default, or after 5 minutes of inactivity, the LCD displays the screen saver.

The backlight LCD automatically dims after 10 minutes of inactivity. Press any button to restore the screen.

The following table describes the status information provided by the UPS

Note. If other indicator appears, see troubleshooting on page 18 for additional information.

Operation status	Possible cause	Action
Standby mode 	The UPS is OFF, waiting for start-up command from user	Equipment is not powered until  button is not pressed.
Normal mode 	The UPS is operating normally.	The UPS is powering and protecting the equipment.
In AVR mode  No beep	The UPS is operating normally but the utility voltage is outside normal mode thresholds.	The UPS is powering the equipment through a Automatic Voltage Regulation device. The equipment is still normally protected.
On Battery  Battery LED is on 1 beep every 10 seconds	A utility failure has occurred and the UPS is in Battery mode.	The UPS is powering the equipment with the battery power. Prepare your equipment for shutdown.
End of backup time  1 beep every 3 seconds	The UPS is in battery mode and the battery is running low.	This warning is approximate, and the actual time to shutdown may vary significantly. Depending on the UPS Load, the "Battery Low" warning may occur before the battery reaches 20 % capacity.

2. Presentation

2.6 Display functions

Press the Enter (↵) button to activate the menu options. Use the two middle buttons (▲ and ▼) to scroll through the menu structure. Press the Enter (↵) button to select an option. Press the ESC button to cancel or return to the previous menu.

Menu map for Display Functions.

Main menu	Submenu	Display information or Menu function
Measurements		Load W VA / Load A pf / Output V Hz / Input V Hz / Battery V min / Efficiency / Power usage
Control	Load Segments	Group 1: ON / OFF Group 2: ON / OFF These commands overrule user settings for load segments.
	Start battery test	Starts a manual battery test
	Reset fault state	Clears active faults
	Restore factory settings	Returns all settings to original values (UPS restart required)
	Reset power usage	Clears power usage measurements
Settings	Local settings	Sets product general parameters
	Input / output settings	Sets Input and output parameters
	ON / OFF settings	Sets ON / OFF conditions
	Battery settings	Sets battery configuration
Fault log		Displays event log or alarms
Identification		UPS Type / Part Number / Serial Number / Firmware release / Com card address

2.7 User settings

The following table displays the options that can be changed by the user.

	Description	Available settings	Default settings
Local settings	Language	[English] [Français] [Deutsch] [Italiano] [Português] [Español] [Русский] Menus, status, notices and alarms, UPS fault, Event Log data and settings are in all supported languages.	English User selectable when UPS is powered for the first time.
	LCD settings	Modify LCD screen brightness and contrast to adapt to room light conditions.	
	Audible alarm	[Enabled] [Disabled on battery] [Always disabled] Enable or disable the buzzer if an alarm occurs.	Enabled
In/Out settings	Output voltage	[200 V] [208 V] [220 V] [230 V] [240 V]	User selectable when UPS is powered for the first time.
	Input thresholds	[Normal mode] [Extended mode] Extended mode reduces lower input voltage to 150 V before UPS transfers to battery. This can be used if the load can withstand low voltage supply.	Normal mode
	Sensitivity	[High] [Low] High: for sensitive equipment, UPS will easily transfer to battery when utility conditions are becoming bad. Low: for equipment that can withstand bad utility conditions, in that case, the UPS will not transfer to battery.	High
	Load segments - Auto start delay	[No Delay] [1 s] [2 s]...[65354 s] The connected load is powered after the specified delay.	Group 1: 3 s Group 2: 6 s

	Description	Available settings	Default settings
In/Out settings	Load segments - Auto shutdown delay	[Disable] [0s] [1 s] [2 s]...[65354 s] During a power outage, authorises to keep some equipment running while turning off other equipment. This feature allows to save battery power.	Group 1: Disable Group 2: Disable
	Overload prealarm	[10 %] [15 %] [20 %] ... [100 %] [105 %] Gives a warning when a predefined critical percentage of load is reached.	[105 %]
ON/OFF settings	Cold start	[Disable] [Enable] Enables the product to be started on battery power. First cold start always disabled.	Enable
	Forced reboot	[Disable] [Enable] If mains recover during a shutdown sequence: - if enabled, shutdown sequence will complete and wait 10 seconds prior to restart - if disabled, shutdown sequence will not complete and restart will occur immediately.	Enable
	Auto restart	[Disable] [Enable] Enables the product to restart automatically when mains recovers after a complete battery discharge.	Enable
	Energy saving	[Disable] [Enable] If enabled, UPS will shutdown after 5min of back-up time, if no load is detected on the output.	Disable
	Sleep mode	[Disable] [Enable] If disabled, LCD and communication will turn OFF immediately after UPS is OFF. If enabled, LCD and communication stays ON 1h30 min after UPS is OFF.	Disable
	Remote command	[Disable] [Enable] If enabled, shutdown or restart commands from software are authorised.	Enable
	RPO delay	[0 s] [1s] [2 s]...[180 s] Delays remote power off command	[0 s]
Battery settings	Automatic battery test	[No test] [Every day] [Every week] [Every month] Available only if battery charge mode is set to constant charge.	Every week (in constant charge, otherwise following ABM battery test method)
	Low battery warning	[1 %] [2 %] ... [100 %] The alarm triggers when the set percentage of battery capacity is reached during a back-up time.	20 %
	Restart battery level	[1 %] [2 %] ... [100 %] If set, automatic restart will occur only when percentage of battery charge is reached.	0 %
	Battery charge mode	[ABM cycling] [Constant charge]	ABM cycling
	Deep discharge protection	[Yes] [No] If set to Yes, the UPS automatically prevents battery from deep discharge by adapting end of back-up time voltage threshold.	Yes

3. Installation

3.1 Unpacking and contents check

Tower models

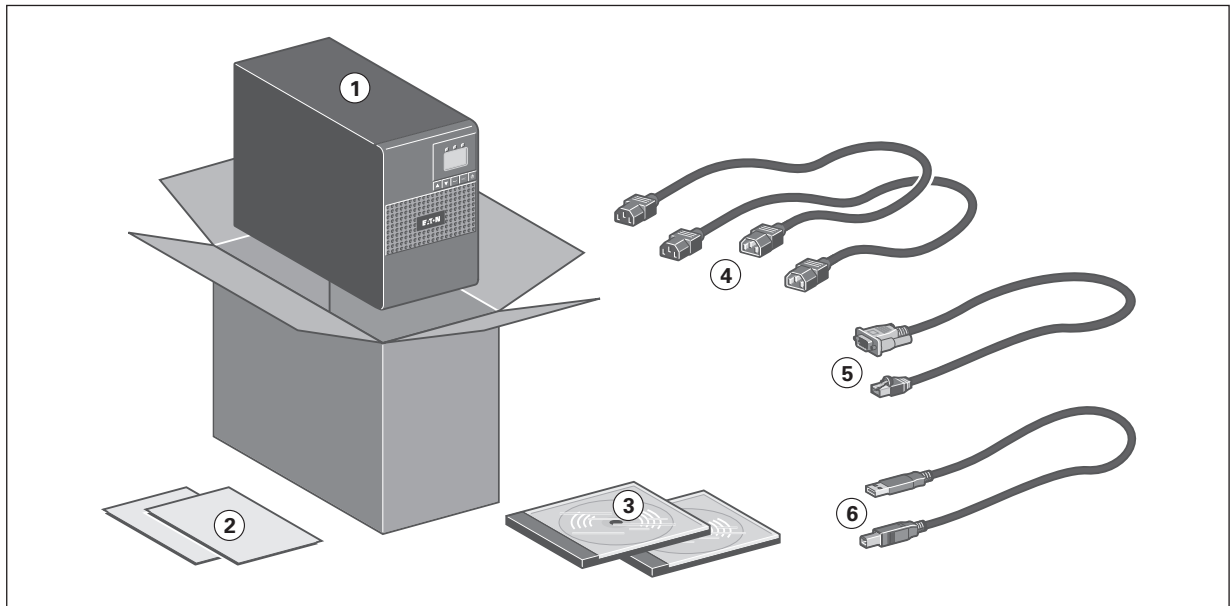

Rack models

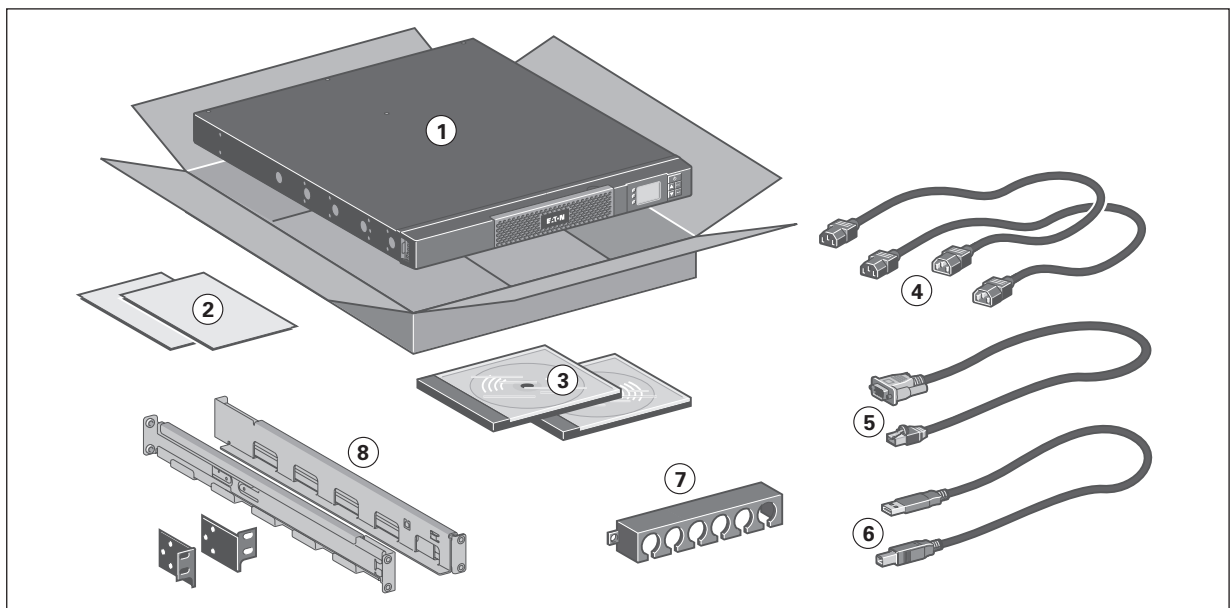

- (1) 5P UPS
- (2) Quick start and safety instructions
- (3) User manual and IPSS (Intelligent Power Software Suite) CDROM
- (4) 2 connection cables for the protected equipment
- (5) RS232 communication cable
- (6) USB communication cable
- (7) Cable locking systems (1 x 4 outlets 650i R and 850i R models; 1 x 6 outlets 1150i R and 1550i R models)
- (8) 1U Rack kit (ears only for 650i R model)



Packing materials must be disposed of in compliance with all local regulations concerning waste. Recycling symbols are printed on the packing materials to facilitate sorting.

3.2 Installation of tower models

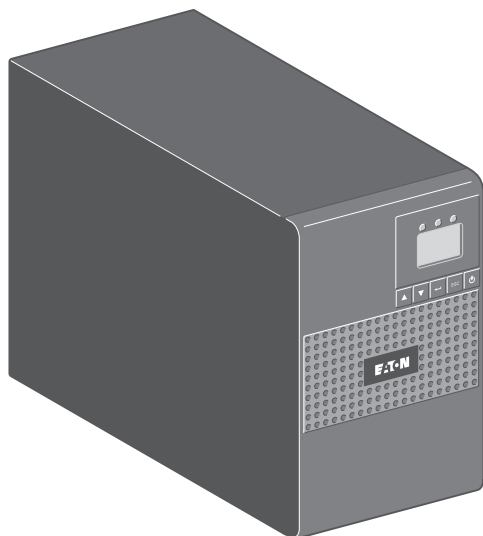

3.3 Wall installation of rack models (650i R / 850i R / 1150i R)

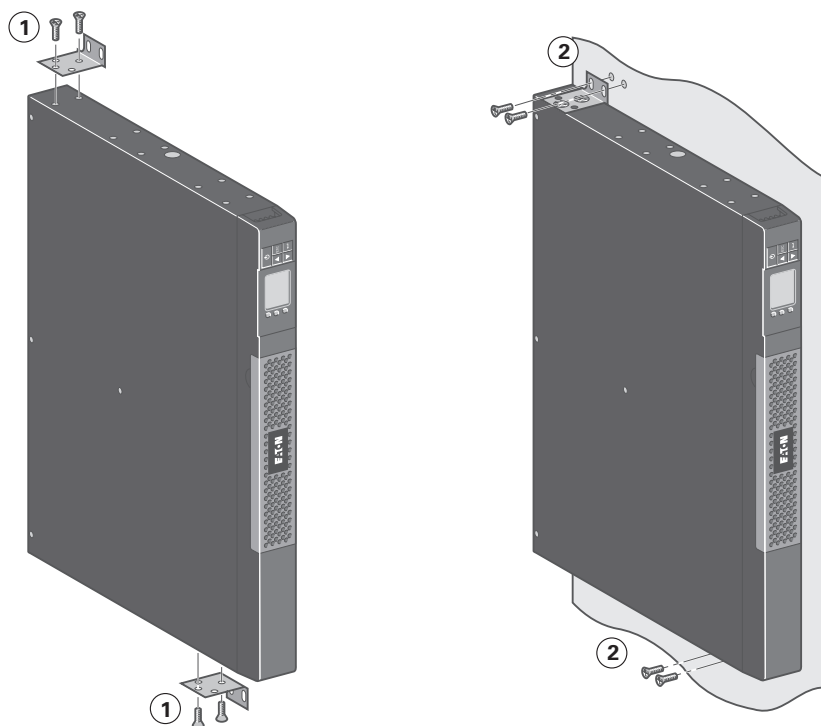

3. Installation

3.4 Installation of rack models (650i R only)

Follow steps 1 to 3 for rack mounting.

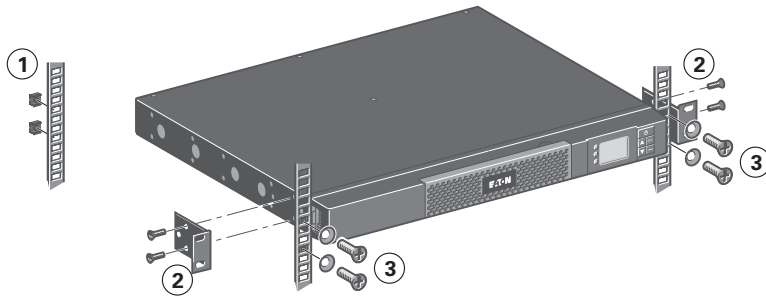

3.5 Installation of rack models (850i R / 1150i R / 1550i R)

Follow steps 1 to 4 for module mounting on the rails.

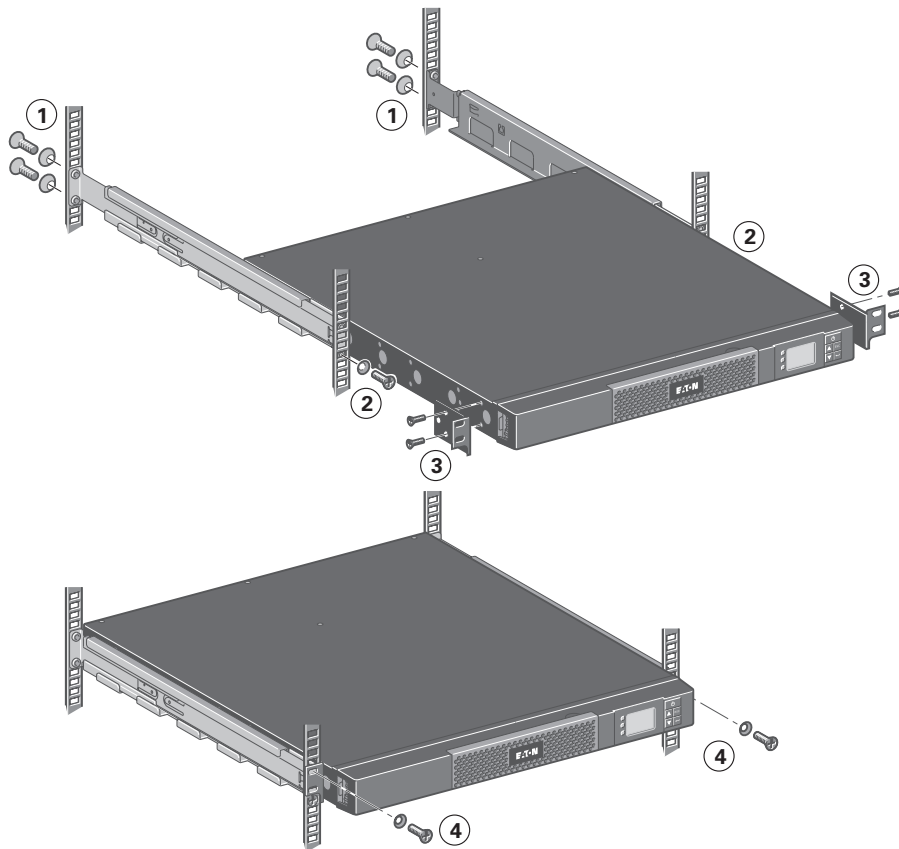

The rails and necessary hardware are supplied by EATON.

3.6 Communication ports

Connection of RS232 or USB communication port

The RS232 and USB communication ports cannot operate simultaneously.

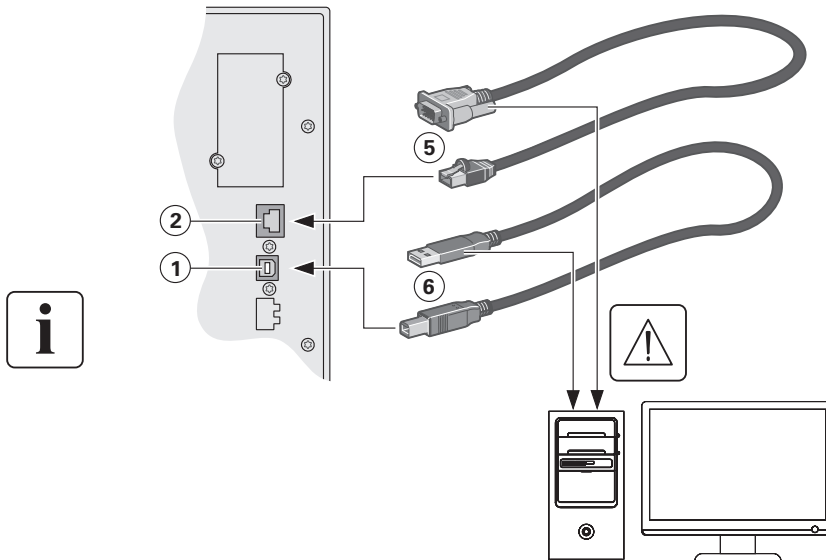

1. Connect the RS232 (5) or USB (6) communication cable to the serial or USB port on the computer equipment.
2. Connect the other end of the communication cable (5) or (6) to the USB (1) or RS232 (2) communication port on the UPS.

The UPS can now communicate with EATON power management software.

Installation of the communication cards (optional)

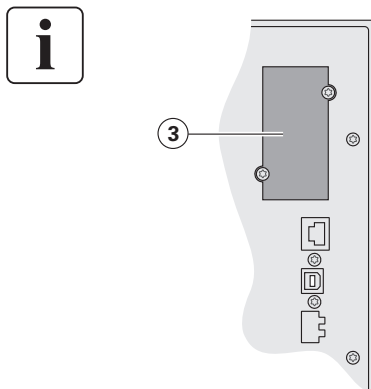

It is not necessary to shutdown the UPS before installing a communication card.

1. Remove the slot cover (3) secured by screws.
2. Insert the communication card in the slot.
3. Secure the card cover with the 2 screws.

Characteristics of the optocouplers communication port (optional)

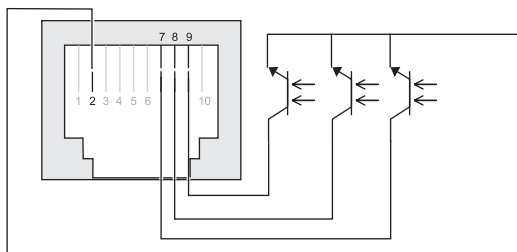

- Pins 1, 3, 4, 5, 6, 10: not used
- Pin 2: common (user)
- Pin 7: low battery
- Pin 8: operation on battery power
- Pin 9: UPS ON, equipment supplied

n.o.: normally open contact

When a signal is activated, the contact is closed between the common (pin 2) and the pin for the corresponding signal.





Contact characteristics (optocoupler)

- Voltage: 48 V DC max
- Current: 25 mA max
- Power: 1.2 W

4. Operation

4.1 Start-up and Normal operation

To start the UPS:

1. Verify that the UPS power cord is plugged in.
2. The UPS front panel display illuminates and shows EATON logo.
3. Verify that the UPS status screen shows .
4. Press the  button on the UPS front panel for at least 2 seconds.
The UPS front panel display changes status to "UPS starting...".
5. Check the UPS front panel display for active alarms or notices. Resolve any active alarms before continuing. See "Troubleshooting" on page 18.
If the  indicator is on, do not proceed until all alarms are clear. Check the UPS status from the front panel to view the active alarms. Correct the alarms and restart if necessary.
6. Verify that the  indicator illuminates solid, indicating that the UPS is operating normally and any loads are powered and protected.
The UPS should be in Normal mode.



4.2 Starting the UPS on Battery



Before using this feature, the UPS must have been powered by utility power with output enabled at least once.



Battery start can be disabled. See the "Cold start" setting in "ON/OFF Settings" on page 11.

To start the UPS on battery:

1. Press the  button on the UPS front panel until the UPS front panel display illuminates and shows a status of "UPS starting...".
The UPS cycles through Standby mode to Battery mode. The  indicator illuminates solid.
The UPS supplies power to your equipment.
2. Check the UPS front panel display for active alarms or notices besides the "Battery mode" notice and notices that indicate missing utility power. Resolve any active alarms before continuing.
See "Troubleshooting" on page 18.
Check the UPS status from the front panel to view the active alarms. Correct the alarms and restart if necessary.



4.3 UPS Shutdown

To shut down the UPS:

1. Press the  button on the front panel for three seconds.
The UPS starts to beep and shows a status of "UPS shutting OFF...". The UPS then transfers to Standby mode, and the  indicator turns off.

4.4 Operation on Battery Power

Transfer to battery power

- The connected devices continue to be supplied by the UPS when AC input power is no longer available. The necessary energy is provided by the battery.
- The  and  indicator illuminates solid.
- The audio alarm beeps every ten seconds.



The connected devices are supplied by the battery.

Low-battery warning

- The \sim and BATT indicator illuminates solid.
- The audio alarm beeps every three seconds.



The remaining battery power is low. Shut down all applications on the connected equipment because automatic UPS shutdown is imminent.

End of battery backup time

- LCD displays "End of backup time".
- All the LEDs go OFF.
- The audio alarms stops.

4.5 Return of AC Input Power

Following an outage, the UPS restarts automatically when AC input power returns (unless the restart function has been disabled) and the load is supplied again.

4.6 UPS remote control functions

The 5P offers a choice between two remote control functions.

- **RPO: Remote Power Off** allow a remote contact to be used to disconnect all the equipment connected to the UPS. Restarting the UPS requires manual intervention.
- **ROO: Remote ON/OFF** allows remote action of button U to shut down the UPS.

These functions are obtained by opening a contact connected between the appropriate pins of connector (4) on the rear panel of the UPS (see figures below).

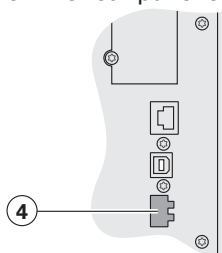

Remote control connection and test

1. Check that the UPS is OFF and disconnected from the AC input source.
2. Remove connector (4) after unscrewing the screws.
3. Connect a normally closed volt-free contact (60 V DC / 30 V AC max., 20 mA max., 0.75 mm² cable cross-section) between the two pins of connector (4) (see diagram).

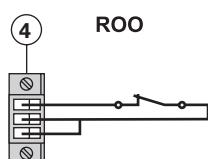

ROO

Contact open: UPS shutdown

Contact closed: UPS start-up (UPS connected to AC power and AC power is available)

Note. The local ON/OFF control using button U overrides the remote-control function.

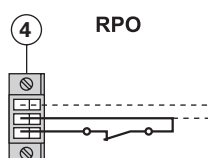

RPO

Contact open: UPS shutdown, LED Δ goes ON.

To return to normal operation, deactivate the remote external contact and restart the UPS by pressing button U .







4. Plug connector (4) into the back of the UPS.
5. Connect and restart the UPS following the previously described procedures.
6. Activate the external remote shutdown contact to test the function.



Warning. This connector must only be connected to SELV (Safety Extra-Low Voltage) circuits.

5. Maintenance

5.1 Troubleshooting

Operation status	Possible cause	Action
Batteries disconnected 	The UPS does not recognise the internal batteries The batteries are disconnected	If the condition persists, contact your service representative Verify that all batteries are properly connected. If the condition persists, contact your service representative.
Overload 	Power requirements exceeds the UPS capacity (greater than 105 % of nominal)	Remove some of the equipment from the UPS. The UPS continues to operate, but may shutdown if the load increases. The alarm resets when the condition becomes inactive.
End of battery life 	The end of the battery life is reached.	Contact your service representative for battery replacement.
Event 	An UPS event occurs Example: Remote Power OFF, the RPO contact has been activated to shutdown the UPS and now prevents restart.	Set the contact back to its normal position and press  button to restart.
UPS fault 	The UPS has an internal fault.	The UPS does not protect the equipment anymore. Note. the alarm message and the UPS Serial Number, then contact your service representative.

5.2 Battery-module replacement

Safety recommendations

The battery can cause electrocution and high short-circuit currents. The following safety precautions are required before servicing the battery components:

- remove watches, rings, bracelets and all other metal objects from the hands and arms,
- use tools with an insulated handle.

Battery tray removal on tower models

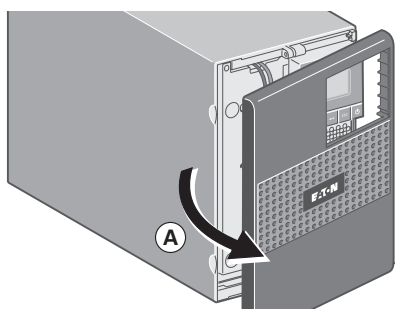

A - Remove the front panel.

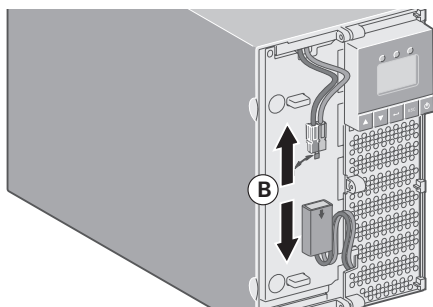

B - Disconnect the battery block by separating the two connectors (never pull on the wires).

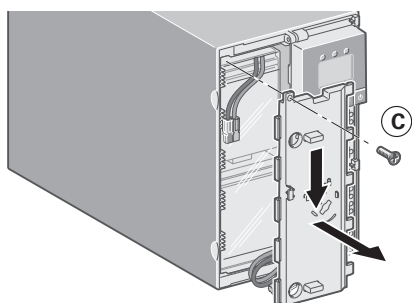

C - Remove the plastic protection cover in front of the battery (one screw).

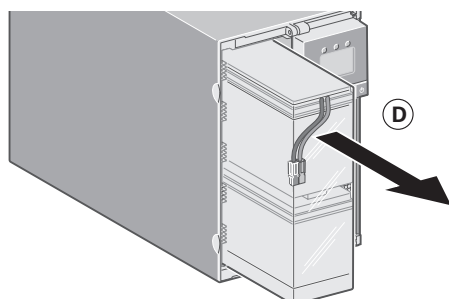

D - Pull the plastic tab to remove the battery block and replace it.

Mounting the new battery module

Carry out the above instructions in reverse order.



- To ensure safety and high performance, use only batteries supplied by EATON.
- Take care to firmly press together the two parts of the connector during remounting.

5. Maintenance

Battery tray removal on rack models

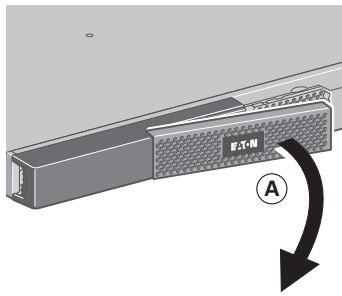

A - Remove the front panel.

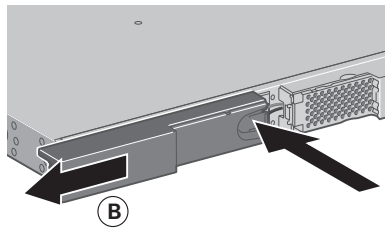

B - Remove the left-hand side of the front panel by pushing the button and then by sliding the part.

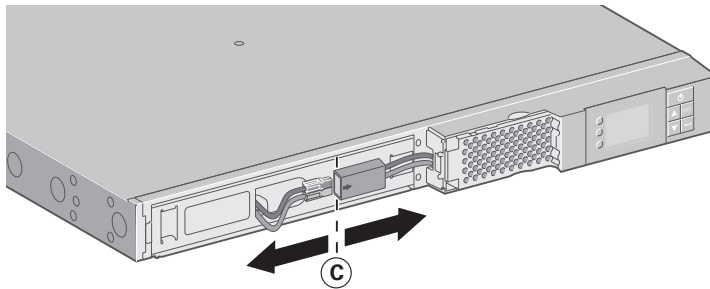

C - Disconnect the battery block by separating the two connectors (never pull on the wires).

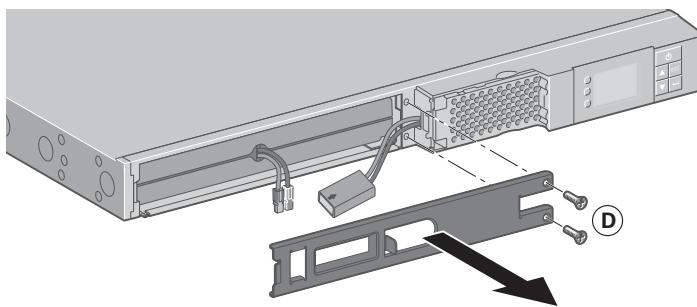

D - Remove the metal protection cover in front of the battery (two screws).

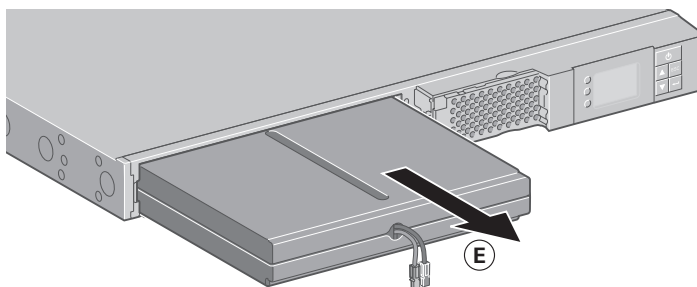

E - Pull the plastic tab to remove the battery block and replace it.

Mounting the new battery module

Carry out the above instructions in reverse order.



- To ensure safety and high performance, use only batteries supplied by EATON.
- Take care to firmly press together the two parts of the connector during remounting.

6.1 Technical specifications

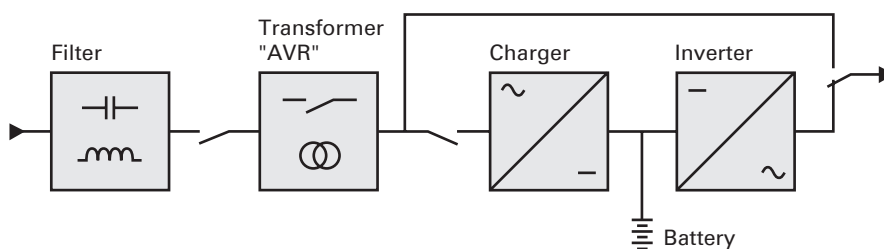

Tower	5P 650i	5P 850i	5P 1150i	5P 1550i
Rack	5P 650i R	5P 850i R	5P 1150i R	5P 1550i R
Output Power @ 230 V	650 VA 420 W	850 VA 600 W	1150 VA 770 W	1550 VA 1100 W
Output Power @ 208 V	585 VA 378 W	765 VA 540 W	1035 VA 693 W	1395 VA 990 W
Output Power @ 200 V	585 VA 378 W	765 VA 540 W	1035 VA 693 W	1395 VA 990 W
AC Input power				
• Rated input voltage	Single phase 200-240 V			
• Input voltage range	160 to 294 V ⁽¹⁾			
• Input frequency range	47 to 70 Hz (50 Hz system), 56,5 to 70 Hz (60 Hz system) ⁽²⁾			
Output on battery power				
• Voltage	200/208/220/230/240 V (-10/+6 %) ⁽³⁾			
• Frequency	50/60 Hz ±0.1 Hz			
Battery (sealed lead acid, maintenance free)				
• Standard	Tower			
	1 x 12 V 9 Ah	2 x 12 V 7 Ah	2 x 12 V 9 Ah	3 x 12 V 9 Ah
	Rack			
	2 x 6 V 9 Ah	4 x 6 V 7 Ah	4 x 6 V 9 Ah	6 x 6 V 9 Ah
Environment				
• Operating temperature range	0 to 35 °C			0 to 40 °C
• Storage temperature range	-15 to +50 °C			
• Relative humidity	0 to 90 % (without condensation)			
• Noise level	< 40 dBA			

(1) The high and low thresholds can be adjusted using UPS settings (up to 150-294 V).

(2) Up to 40 Hz in low -sensitivity mode (programmable using UPS settings).

(3) Adjustable to 200/208/220/230/240 V, must be set to the identical AC power source value.

When the appliance is used in EU area, use an external circuit breaker in front of line with rating 16 A, 250 V which is IEC/EN 60898-1 standard compliant;

When the appliance is used in America area, use an external circuit breaker in front of line with rating 20 A, 250 V.

This product is designed for IT power distribution system.

